

PLAN OF SUBDIVISION

Stage No.

Plan Number

PS723548G

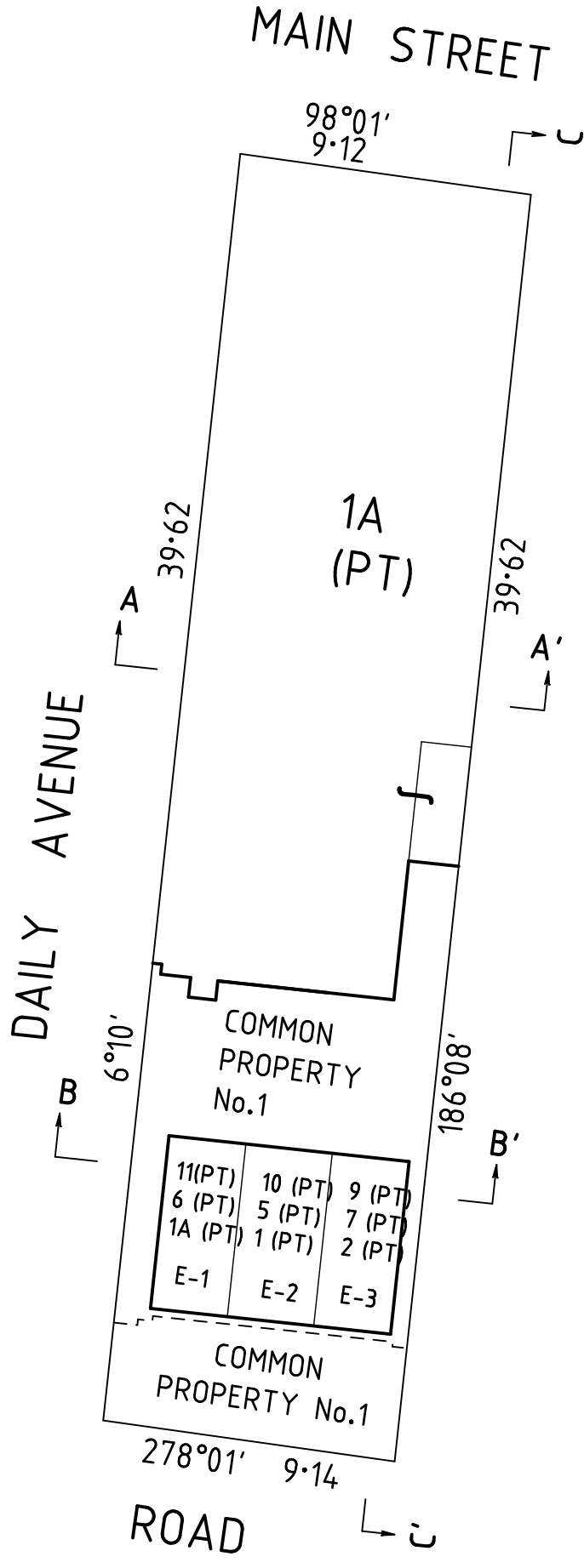

GROUND FLOOR DIAGRAM

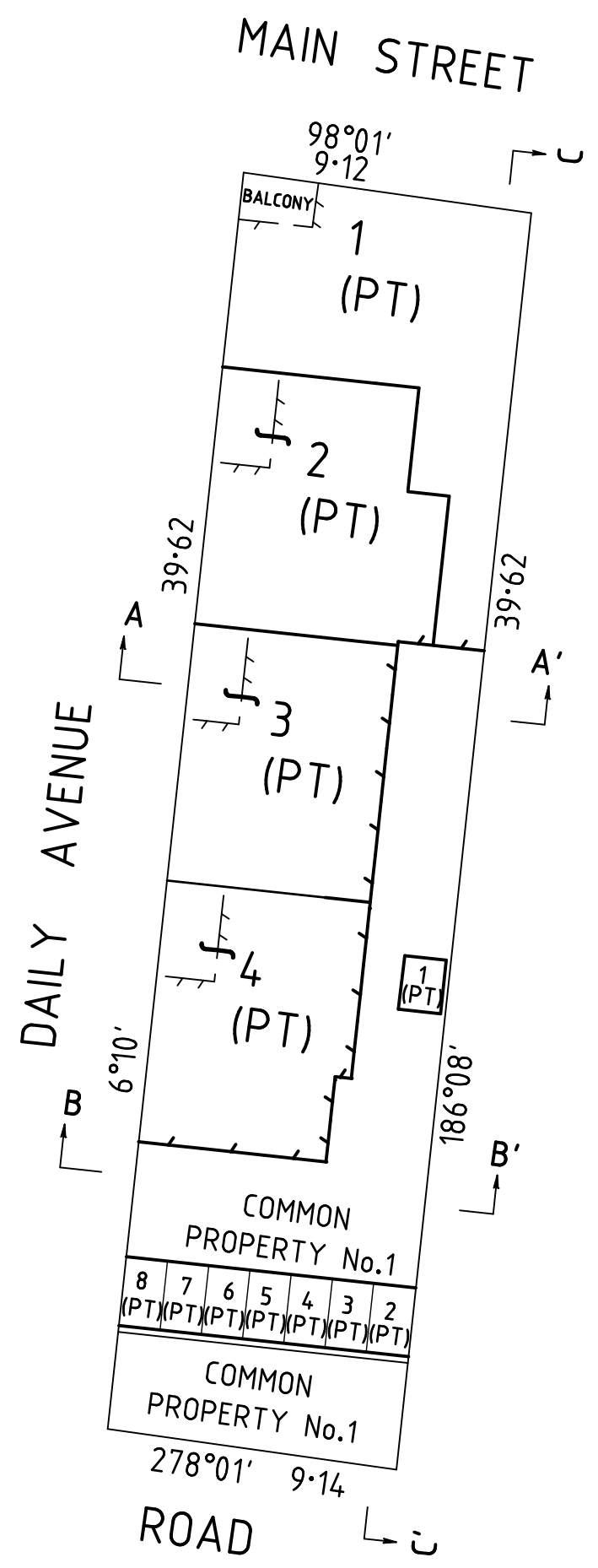

FIRST FLOOR DIAGRAM

Adept Surveys Pty Ltd



161 Sydney Road
Coburg 3058
PO Box 45 Moreland 3058
Ph: (03) 9383 7878
A.C.N. 152 478 503

ORIGINAL	SCALE
SHEET SIZE	1:200
A3	
LENGTHS ARE IN METRES	

LICENSED SURVEYOR (PRINT)

SIGNATURE

DATE / /

REF 589

VERSION 3.1

SHEET 2

DATE / /

COUNCIL DELEGATE SIGNATURE

PLAN OF SUBDIVISION

Stage No.

Plan Number

PS723548G

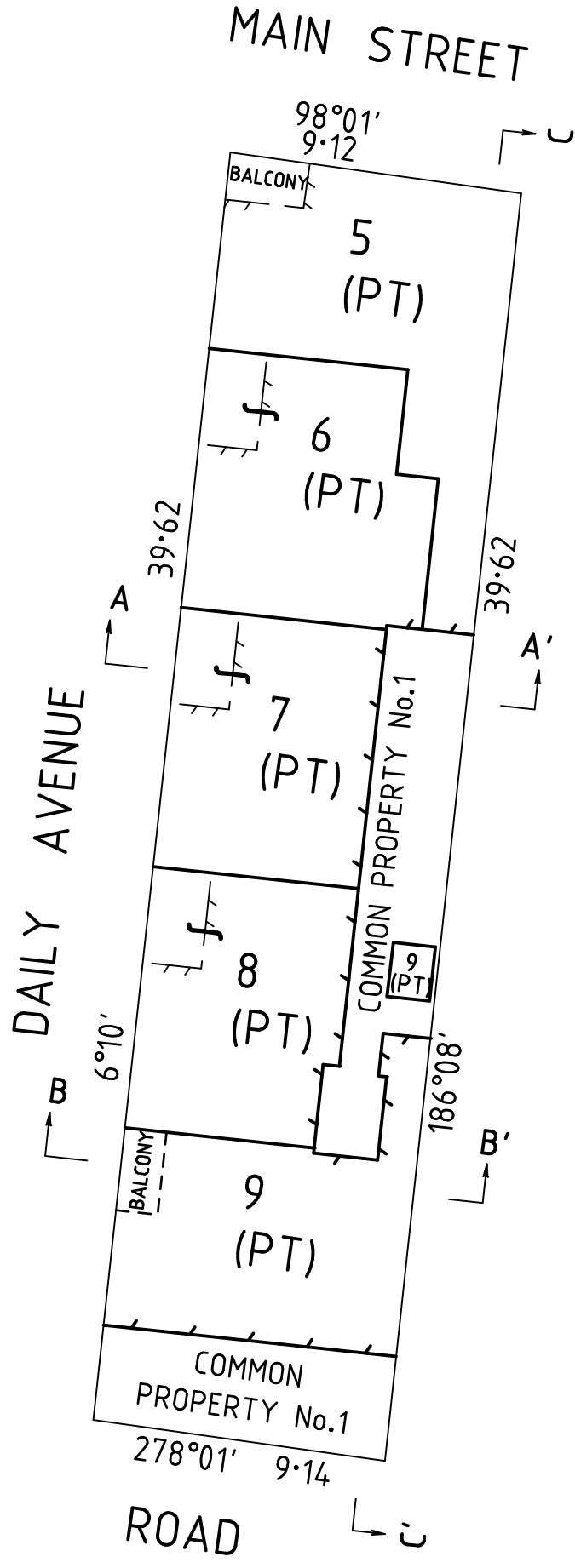
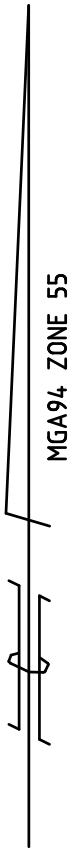

SECOND FLOOR DIAGRAM

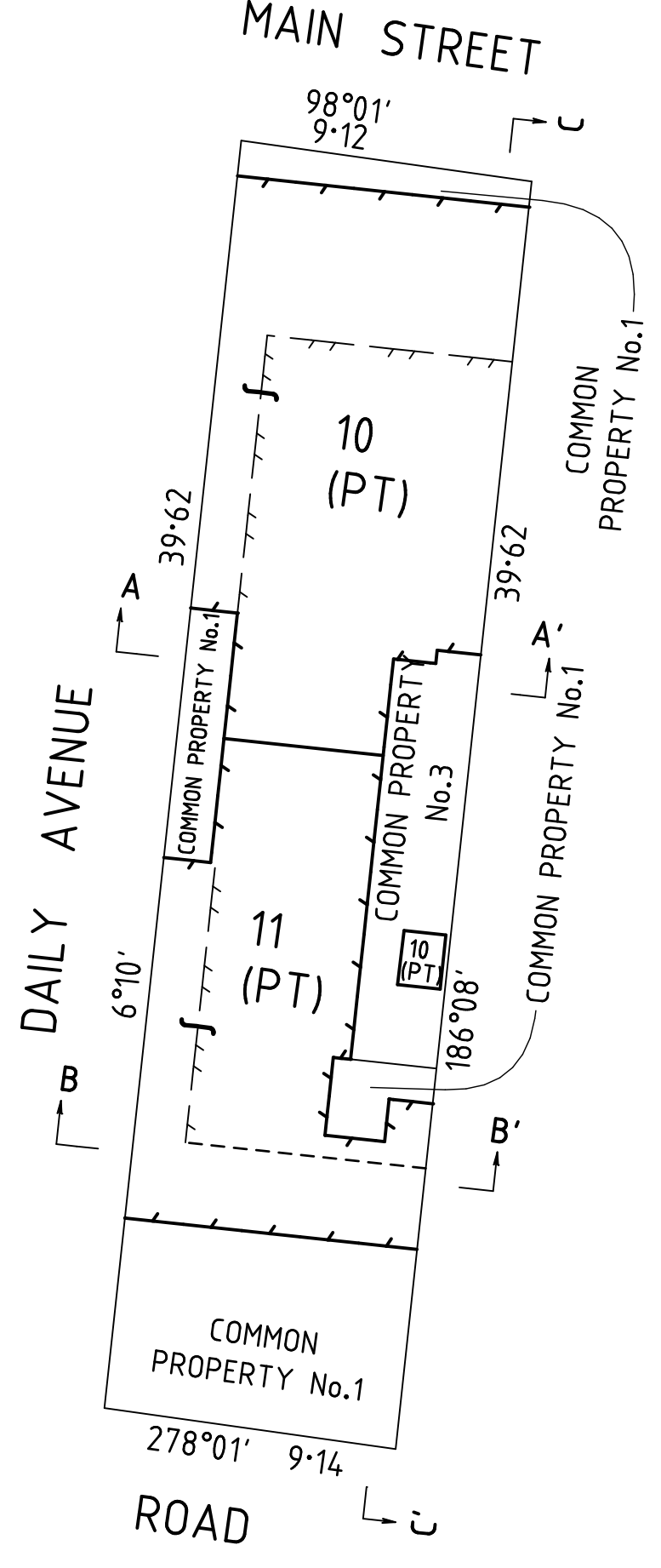

THIRD FLOOR DIAGRAM

Adept Surveys Pty Ltd



161 Sydney Road
Coburg 3058
PO Box 45 Moreland 3058
Ph: (03) 9383 7878
A.C.N. 152 478 503

ORIGINAL	SCALE
SHEET SIZE	1:200
A3	
LENGTHS ARE IN METRES	

LICENSED SURVEYOR (PRINT)

SIGNATURE

DATE

REF 589

VERSION 3.1

SHEET 3

DATE

COUNCIL DELEGATE SIGNATURE

PLAN OF SUBDIVISION

Stage No.

Plan Number

PS723548G

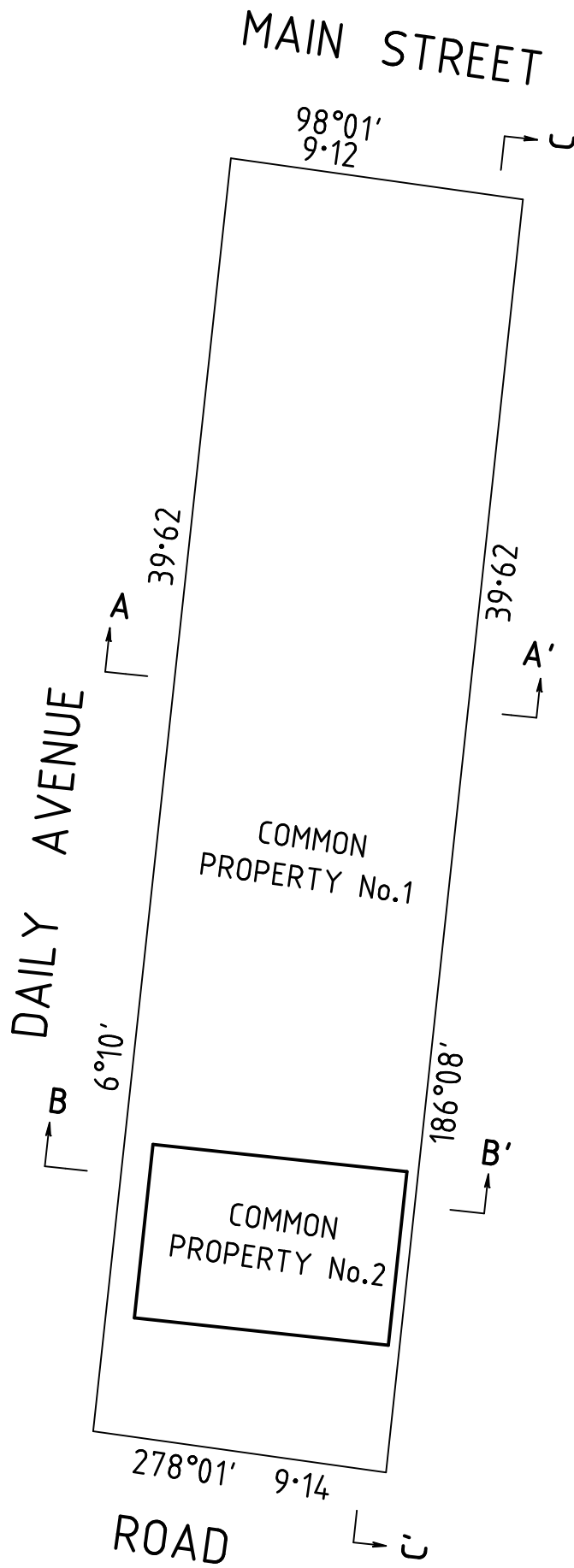

SUB FLOOR DIAGRAM

Adept Surveys Pty Ltd



161 Sydney Road
Coburg 3058
PO Box 45 Moreland 3058
Ph: (03) 9383 7878
A.C.N. 152 478 503

SHEET 4

ORIGINAL	SCALE
SHEET SIZE	SCALE
A3	1:200
LENGTHS ARE IN METRES	

LICENSED SURVEYOR (PRINT)

SIGNATURE

DATE / /

REF 589

VERSION 3.1

DATE / /

COUNCIL DELEGATE SIGNATURE

PLAN OF SUBDIVISION

Stage No. /

Plan Number

PS723548G

- 3RD FLOOR
DIAGRAM 4
- 2ND FLOOR
DIAGRAM 3
- 1ST FLOOR
DIAGRAM 2
- GND FLOOR
DIAGRAM 1
- SUB FLOOR
DIAGRAM 5

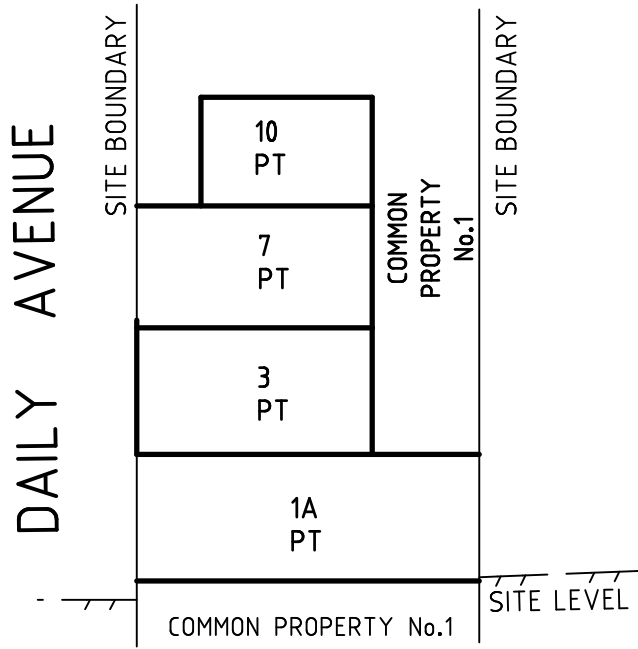

SECTION AA'

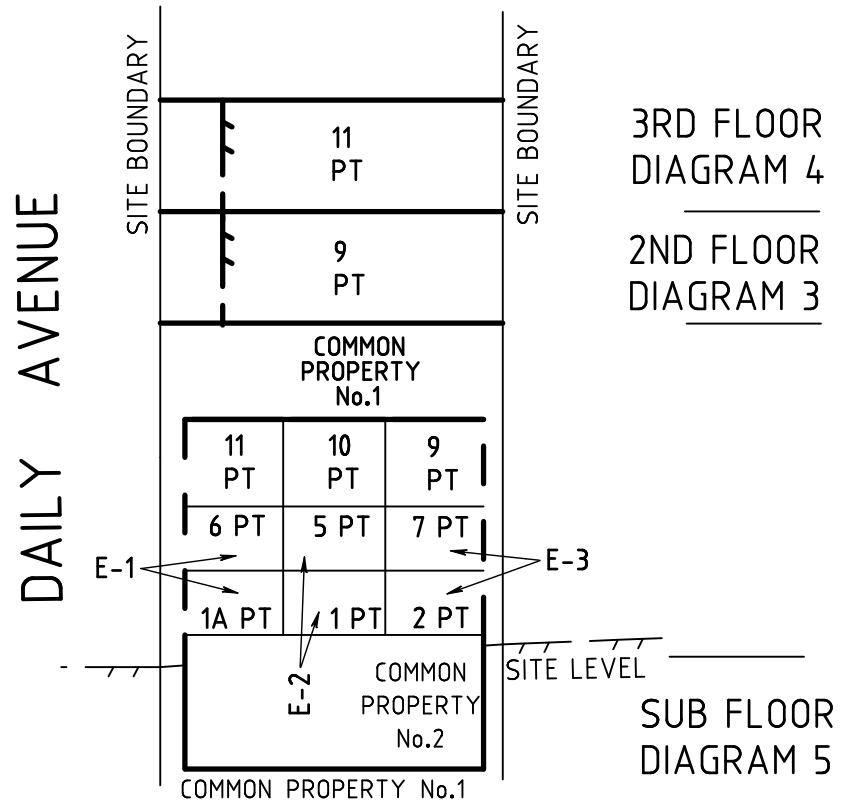

SECTION BB'

- 3RD FLOOR
DIAGRAM 4
- 2ND FLOOR
DIAGRAM 3
- 1ST FLOOR
DIAGRAM 2
- GND FLOOR
DIAGRAM 1
- SUB FLOOR
DIAGRAM 5

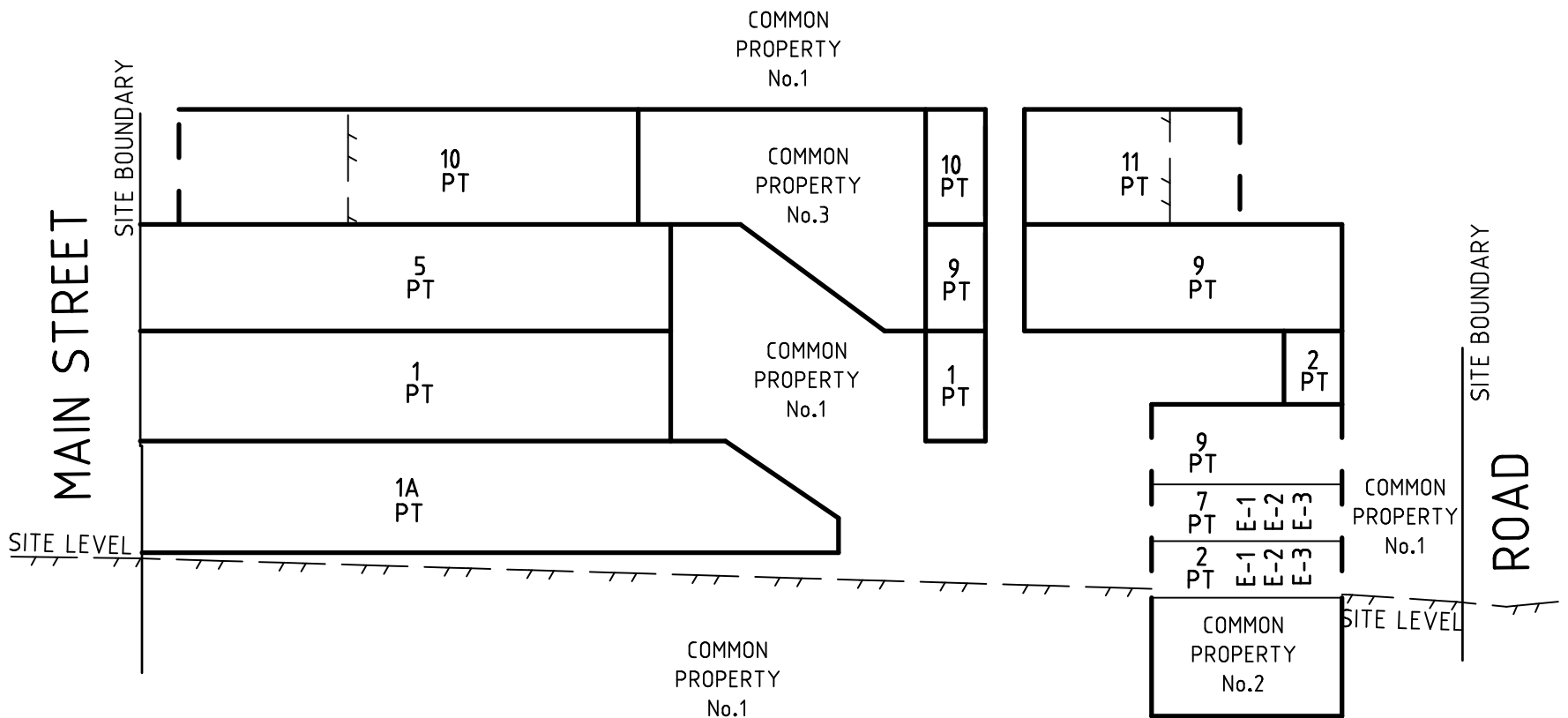

SECTION CC'

Adept Surveys Pty Ltd



161 Sydney Road
Coburg 3058
PO Box 45 Moreland 3058
Ph: (03) 9383 7878
A.C.N. 152 478 503

ORIGINAL	SCALE
SHEET SIZE A3	SCALE 1:200
LENGTHS ARE IN METRES	

LICENSED SURVEYOR (PRINT)

SIGNATURE

REF 589

DATE / /

VERSION 3.1

SHEET 5

DATE / /

COUNCIL DELEGATE SIGNATURE